

© DEN HARTOG INDUSTRIES, INC.

Copyright. All information furnished within this document, electronic file or design correspondence is the property of Den Hartog Industries, Inc. and shall not be used, disclosed to others or copied without the expressed written consent of Den Hartog Industries, Inc.

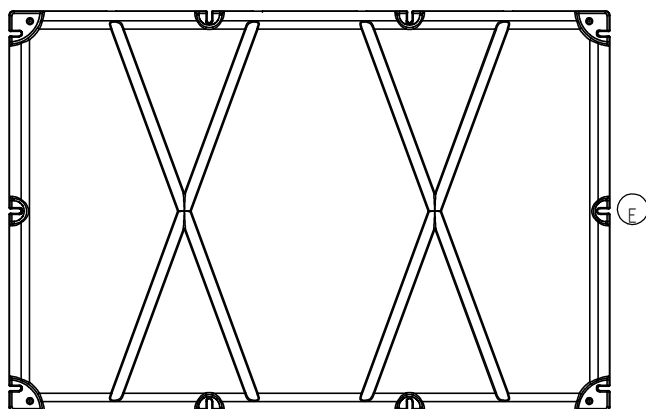
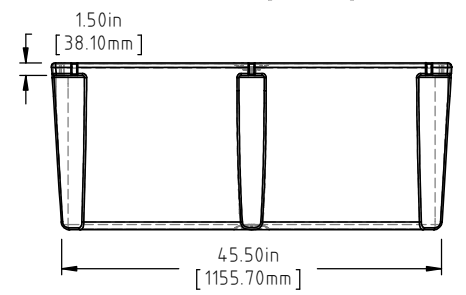
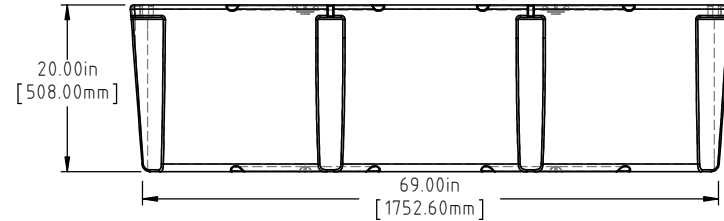
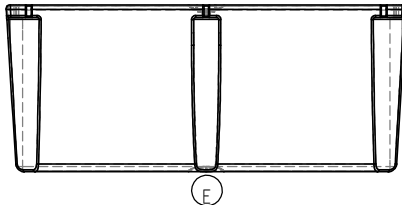
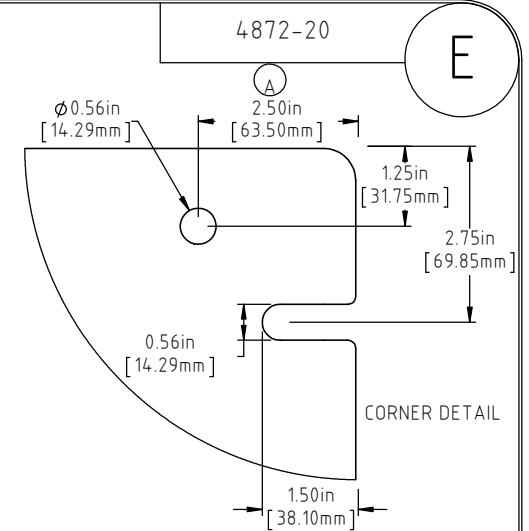
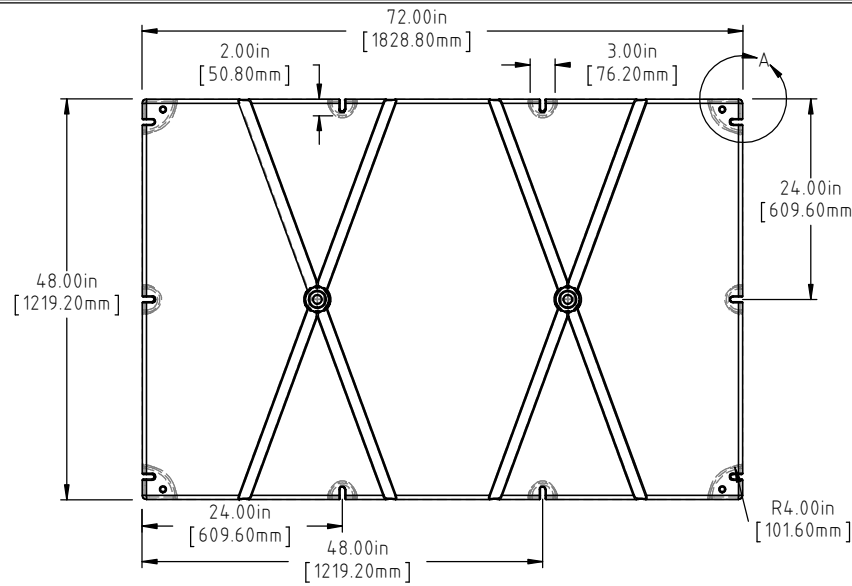

E	BOTTOM/SIDE VIEWS ADDED TO PRINT.	ADH 12/4/14	2971
D	111 LBS WAS 108 LBS, 2225 LBS WAS 2266 LBS	ADH 6/25/12	2420
C	METRIC DIMENSIONS ADDED	ADH 6/19/08	1685
B	ADD BUOYANCY NOTE	GWC 1/11/07	
B	CHANGE WEIGHTS AF WAS 65 FF WAS 116	GWC 1/11/07	
A	2-1/2 WAS 2-1/8	7/10/06	
REV	DESCRIPTION	BY / DATE	CCN

DRAWN / DATE DEAN 11/18/94	MATERIAL POLYETHYLENE
APPRD. / DATE ADH 11/6/07	

NOTE: BUOYANCY IS 2225 LBS.(1009.24 KG)



Den Hartog
INDUSTRIES, INC.

Ace Roto-Mold Injection Molding Blow Molding Sowjoy
4010 HOSPERS DRIVE S. BOX 425, HOSPERS, IOWA 51238-0425

ALL DIMENSIONS ARE IN DECIMAL INCHES
TOLERANCES UNLESS OTHERWISE SPECIFIED
POLYETHYLENE
±1% @ 68°F

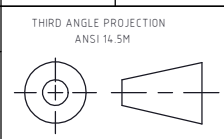

SHOT WEIGHT:
71 LBS. (32.21 KG.)
SHIPPING WEIGHT:
SEE NOTES
FINISH:

NOTES: (A)(C)
1.) AF 71 LBS. (32.21 KG.)
2.) FF 111 LBS. (50.35 KG.)
3.) 0.150 IN (3.81 mm) NOM. WALL

DESCRIPTION 48 X 72 X 20 FLOAT	SCALE N.S.	PART NO. 4872-20
-----------------------------------	---------------	---------------------